

# Mûchtek

TECNOFILES GROUP

Leaders in manufacturing PVC profiles  
for windows and architectural products.

+ TECHNOLOGY  
+ DEVELOPMENT  
+ EVOLUTION

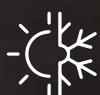

Choose  
efficient  
products

## ABOUT US

»» Our trajectory supports our present.

# Mûchtek

TECNOFILES GROUP

## Why choose us?

Our essence lies in continuous investment in innovation and cutting-edge technology, enabling us to offer a wide range of high-quality and efficient solutions in PVC profile systems for windows and doors.

**MUCHTEK** is the continuation and evolution of Tecnofiles, a sustainable company with a strong track record and recognized presence in the market. **MUCHTEK** paves the way for international growth and expansion within the business of PVC profile systems for windows and doors, ensuring high performance and the development of architectural products.

»» A network of more than 450 certified manufacturing workshops across Latin America, all operating in compliance with European manufacturing standards.

»» Technical and professional consulting services for all types of construction projects.

»» The largest manufacturing plant in Latin America combined with cutting-edge European technology, featuring 9 extruders and a production capacity of 1,000 metric tons per month, set on 7,000 m<sup>2</sup> exclusively dedicated to profile manufacturing for global markets.

»» A 3,000 m<sup>2</sup> distribution center supporting growing national and international demand.

»» A 2,000 m<sup>2</sup> lamination plant equipped with 5 laminating machines that use the greatest cutting-edge technology.

»» A PVC profile recycling plant promoting circular economy and environmental protection.

»» Tecnofiles SA's production plant holds ISO 9001 certification for the Design, Manufacturing, Commercialization and Technical Service of PVC profile systems for windows and doors.



# We protect the environment through maximum energy efficiency.

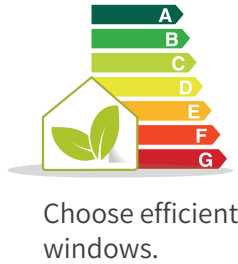

Due to their design and construction, MUCHTEK windows and doors provide maximum thermal insulation, reducing energy consumption. The material's strength, impact resistance, along with metallic reinforcements and perimeter ironwork (combined with double glazing) result in windows and doors that offer the highest levels of water tightness and security.

MUCHTEK promotes the use of materials and designs that enable efficient energy use, leading to a significant reduction in building operational cost.

The company maintains a strong commitment to environment protection and sustainability by implementing processes that do not generate gas emissions or polluting liquids. Furthermore, all PVC profile offcuts rejected during the manufacturing process can be reused in other products. Low thermal conductivity in PVC windows and doors, the multi-chamber profile design, the perimeter locking system and the use of hermetic double glazing -all integral parts of the system- together enable a reduction of more than 50% in energy loss through windows and doors in comparison to other widely used systems.

One of MUCHTEK's main objectives is to accomplish greater energy efficiency and optimal use of natural resources. In line with this goal, improving thermal and acoustic insulation through windows helps reduce energy consumption and CO2 emissions into the atmosphere.



As part of its commitment to sustainable construction and to raising awareness of climate change and environmental issues, the company is a member of the **Argentina Green Building Council**. Operating under the World Green Building Council's licence, the Council serves as a supporting network for implementing both global and local sustainability initiatives.

MUCHTEK's profile systems contribute to earning points under LEED standards in the following categories:

- › Materials and resources.
- › Environmental quality.
- › Energy and atmosphere.



In this way, we promote sustainable development and environmentally conscious design, supporting green initiatives and fostering the integration of sustainable technologies within the building industry. In line with this commitment, MUCHTEK adheres to various laws, decrees and national regulations aimed at promoting rational and efficient energy use.

In collaboration with the Undersecretary of Energy and Mining, we have developed an **Energy Efficiency Label for Exterior Windows**, promoting the use of efficient windows that reduce energy loss in homes. The company participates in various

committees of IRAM (Argentine Institute of Certification and Standardization), focusing on regulatory studies in areas such as Sustainable Construction, Energy Efficiency, Acoustics and Electroacoustics, Construction Carpentry and Light Facades).

By accessing to [www.etiquetadoventanas.energia.gob.ar](http://www.etiquetadoventanas.energia.gob.ar), you can learn more about energy efficiency labeling according to **IRAM standard 11507-6**.

Energía	Clasificación energética en período de calefacción				
	Zona 1	Zona 2	Zona 3	Zona 4	Zona 5
MUCHTEK PUERTA JUMBO 3 HOJAS	A	B	A	B	B
Más eficiente	A	B	A	B	B
B					
C					
D					
E					
F					
G					
Menos eficiente	A	C	A	A	No aplica
Clasificación energética en período de refrigeración	A	C	A	A	No aplica
Ancho x Alto	4,50 x 3,05 m				
Transparencia	1,60 Wind K				
Índice del vidrio	2,38 Wind K				
Transparencia	0,02 Wind K				
Índice del DVIH	0,373				
Factor Solar	2 m3h.m				
Infiltración Aire	2 m3h.m				
Tipología DVIH	4 + 4				
Vidrio 4+2	12				
Bloque solar medio	2 + 3 Lintel				
Clasificación Energía	2				

**Our PVC profiles**

**Always leading the way**

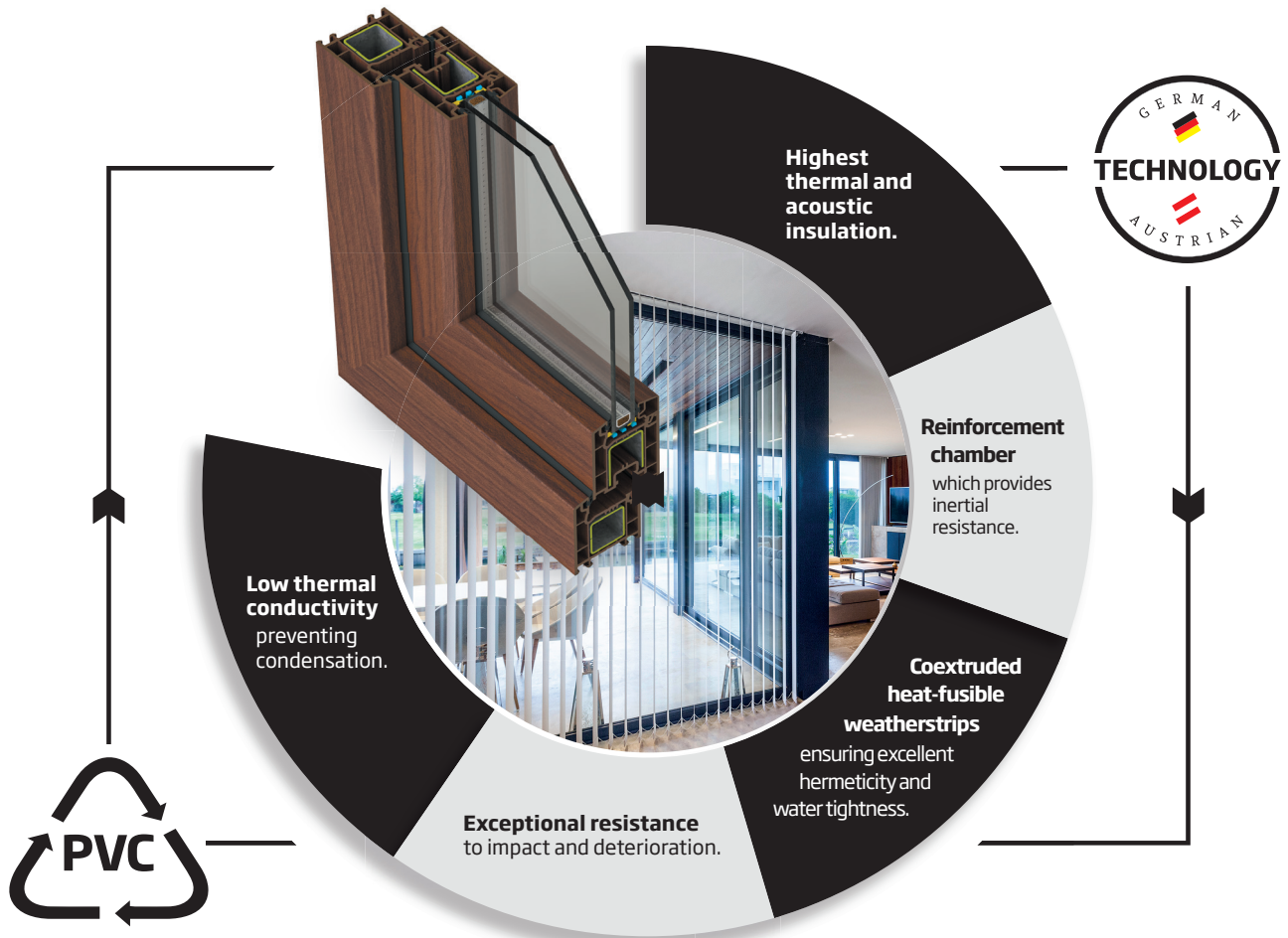

## Advantages of PVC doors and windows



Energy saving



Thermoacoustic insulation



Airtightness and tightness



Durability and resistance



Safety, fireproof



Variety of colors



Minimum maintenance



Wide range of designs



» Global leaders in ensuring the highest quality and cutting-edge technology.

Composition

 <b>Unipar</b> PVC Resin <a href="http://www.unipar.com">www.unipar.com</a> 	 <b>INEOS</b> Titanium Dioxide <a href="http://www.ineos.com">www.ineos.com</a> 	 <b>DOW</b> Impact Modifier <a href="http://www.dow.com/es-ar">www.dow.com/es-ar</a> 	 <b>OMNOVA SOLUTIONS</b> Thermoplastic Rubber <a href="http://www.omnova.com">www.omnova.com</a> 	 <b>nitriflex</b> Thermoplastic Rubber <a href="http://www.nitriflex.com.br">www.nitriflex.com.br</a> 	 <b>REAGENS VARTECO</b> Calcium Zinc Stabilizer <a href="http://www.reagensvarteco.com">www.reagensvarteco.com</a> 
--	--	---	---	--	---

Guaranteed Quality

 <b>Q-LAB XENON TEST</b> Deterioration Chamber <a href="http://www.q-lab.com/es-es">www.q-lab.com/es-es</a> 		 <b>KLEIBERIT</b> ADHESIVES • COATINGS Laminating Adhesives <a href="http://www.kleiberit.com">www.kleiberit.com</a> 
 <b>TK</b> Laminating Adhesives <a href="http://www.taka.it">www.taka.it</a> 		 <b>ASCONA</b> PROFILE MEASURING TECHNOLOGY Dimensions Measurement Equipment <a href="http://www.ascona.de">www.ascona.de</a> 
 <b>KS</b> Maschinenbau Window Test Rig <a href="http://www.ksschulten.com">www.ksschulten.com</a> 		 <b>Continental</b> Lamination Equipment <a href="http://www.continental.com">www.continental.com</a> 

Production Technology

 <b>exelliq</b> Greiner Tooling <a href="http://www.exelliq.com">www.exelliq.com</a> 	 <b>KraussMaffei</b> Extruders <a href="http://www.kraussmaffei.com">www.kraussmaffei.com</a> 	 <b>BARBERÁN</b> Laminating Machines <a href="http://www.barberan.com">www.barberan.com</a> 
---	--	--



**BIM** Building Information Modeling



Scan the QR code



















Learn more about our systems and typologies. Download all files from our BIM virtual library.

» Download all our windows from the BIM MUCHTEK virtual library.

- › MUCHTEK Systems and typologies.
- › Building details available in ArchiCad, PDF, REVIT and CAD formats.
- › Technical information for each product.
- › Information on certifications and testing.

» [www.muchtekt.com/BIM](http://www.muchtekt.com/BIM)

## Profile composition

	<p>PVC Resin <b>UNIPAR</b> www.unipar.com</p>		
	<p>Impact Modifier <b>DOW</b> www.dow.com</p>		
	<p>Titanium Dioxide <b>INEOS</b> www.ineos.com</p>		
	<p>Thermoplastic Rubber <b>OMNOVA</b> www.omnova.com</p>		
	<p>Thermoplastic Rubber <b>NITRIFLEX</b> www.nitriflex.com.br</p>		
	<p>Calcium Zinc Stabilizer <b>REAGENS-VARTECO</b> www.reagensvarteco.com</p>		

PVC is environmentally friendly and highly durable. It features low thermal conductivity, is fire-resistant, and offers long-lasting performance.









**MUCHTEK** formulations incorporate a high proportion of impact modifiers, ensuring compliance with the UNE12608 European Standard for impact resistance.

The titanium dioxide used in our formulations is sourced from North America and provides up to 10 years of outdoor durability.

We use French thermoplastic rubber that allows the weatherstrips of our profiles to be fully heat-fusible, ensuring excellent water tightness.

The calcium zinc stabilizer ensures thermal stability and prevents discoloration during the PVC profile extrusion process.

## Production technology

	<p>Extruders <b>KRAUSSMAFFEI</b> www.kraussmaffe.com</p>		
	<p>Tooling <b>GREINER / EXELLIQ</b> www.exelliq.com</p>		
	<p>Laminating machines <b>BARBERAN</b> www.barberan.com</p>		

We operate several extruders that allow us to achieve an annual production capacity of 12,000 metric tons of profiles.

We use Austrian Red Toolings, the latest generation of technology developed globally by Greiner.

We implement innovative Hotmelt technology to ensure the highest quality throughout the lamination process.

# Guaranteed quality



**Arc test chamber**  
**XENON TEST**  
[www.q-lab.com/es-es](http://www.q-lab.com/es-es)



Xenon Test is a full-featured lightfastness, weathering, and photostability chamber that reproduce the damage caused by full-spectrum sunlight, heat, and water.



**Window test rig**  
**KS SCHULTEN**  
[www.ksschulten.com](http://www.ksschulten.com)



The test rig enables performance rating of PVC windows under IRAM standards for air permeability, water tightness and wind resistance.



**Profile dimensional measurement**  
**ASCONA**  
[www.ascona.de](http://www.ascona.de)



We use the latest cutting-edge European technology to carry out dimensional measurements of profiles during the laboratory quality control process.



**Lamination processes**  
**Benecke -Horns**  
**Surface Group**  
[www.continental-corporation.com](http://www.continental-corporation.com)



The German lamination processes for PVC profiles stand out for their innovative finishes, refined textures, excellent outdoor resistance and long-lasting durability.



**Laminating adhesives**  
**KLEIBERIT**  
[www.kleiberit.com](http://www.kleiberit.com)



Thanks to Cool Colors technology (cold pigmentation), surface heating is reduced regardless of color, extending the life cycle of the profiles.

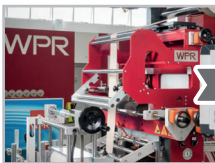

**Laminating adhesives**  
**TAKA**  
[www.taka.it](http://www.taka.it)



## MUCHTEK MEMBERSHIPS

We are part of and support several institutions to promote industry growth, professional updating and continuous improvement.



Vivienda de Hormigón Industrializada en Sitio

# EFFICIENT LINE

## Fixed Panel System

Offered in two profile dimensions: **2,17"** or **2,64"** in depth, which can be applied to Double Contact systems.

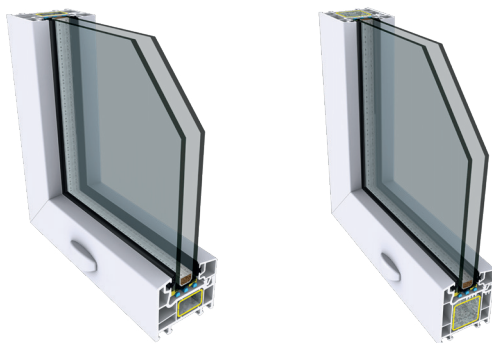

Series **58-55** and **58-67**

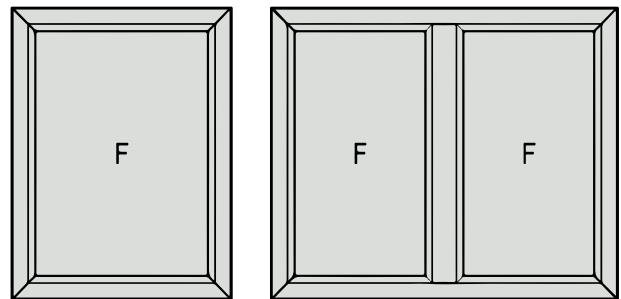

## Double Contact System

**FEATURES THE FOLLOWING SYSTEMS:**  
 Hinged (inward/outward), tilt-and-turn, projecting, awning, folding and parallel sliding.

With internal galvanized steel reinforcements that enable the design of large windows and doors with simple or double glazing up to 1,34" thick.



>> Series **67-100**

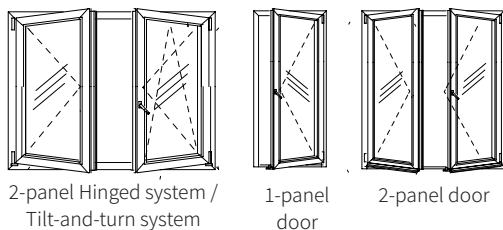

>> Series **55-69, 55-85 and 67-85**

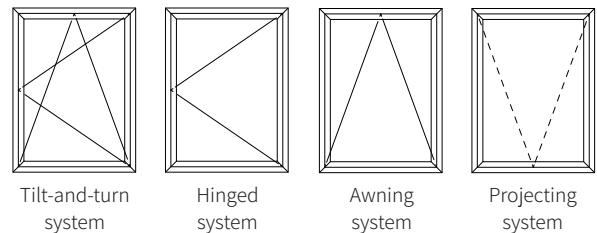



# ECO LINE »

High performance | Low cost

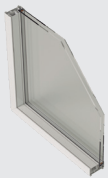

## ECO FIX

Fixed Panel



## ECO HANG

Guillotine



## ECO SLIDE

Sliding fixed / mobile

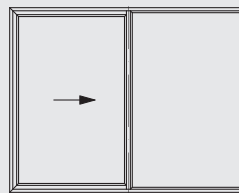

## ECO PATIO DOOR

Sliding fixed / mobile

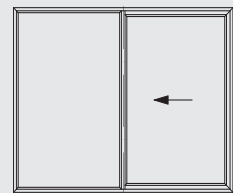

## ECO MINI SLIDE

Lightweight sliding

- > Lightweight sliding system with high assembly efficiency.
- > Suitable for 2 or 3 sashes.
- > Can be laminated in a wide range of colors and textures.

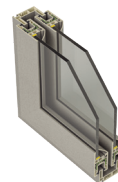

## ECOLIFE

Lightweight double contact

- > Great thermo-acoustic insulation, airtightness and security.
- > Supports single and double glazing up to 17 mm thick.
- > Can be laminated in a wide range of colors and textures.



# PIVOT DOOR

- › Design, style and comfort.
- › Resistance.
- › Thermal and acoustic insulation.
- › Fire-resistant.
- › Low maintenance.
- › Long life cycle.
- › Compatible with single or double glazing up to 1,34" and panels.
- › Multipoint lock.
- › Premium stainless steel hardware.

This door is designed to enhance and make main entrances stand out.

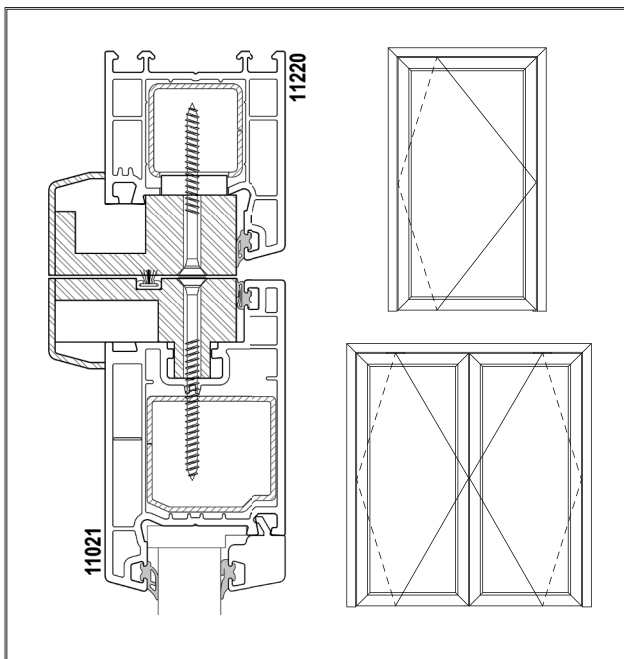

# EVOLUTION LINE

## Fixed-mobile sliding system

### The sliding system evolution.

- › Designed for demanding projects with extreme weather conditions and high wind pressure.
- › Ensures maximum hermeticity and watertightness.
- › Hardware system with active lock points at the central meeting point.
- › Special transverse panel closing mechanism in relation to the frame profile.
- › PVC weatherstrips post co-extruded.
- › Compatible with double or triple hermetic glazing up to 1,81”.
- › Soft-open and soft-close functions provide superior comfort and security for users.

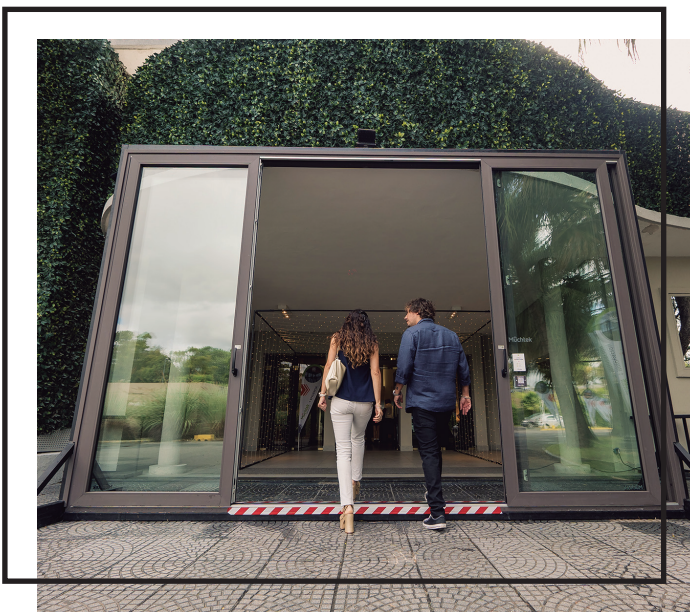

11090: Evolution panel

11127: Mullion 70

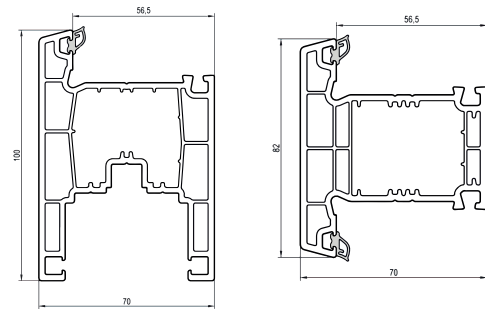

#### Horizontal cuts

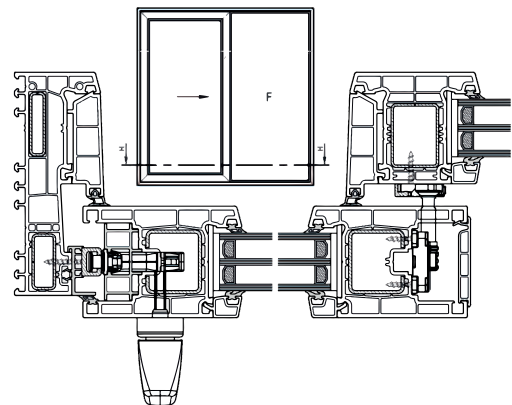

11290: Evolution Frame

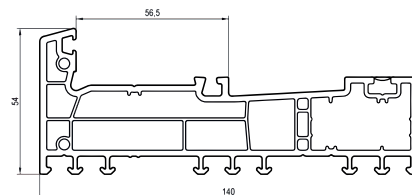

#### Vertical cuts

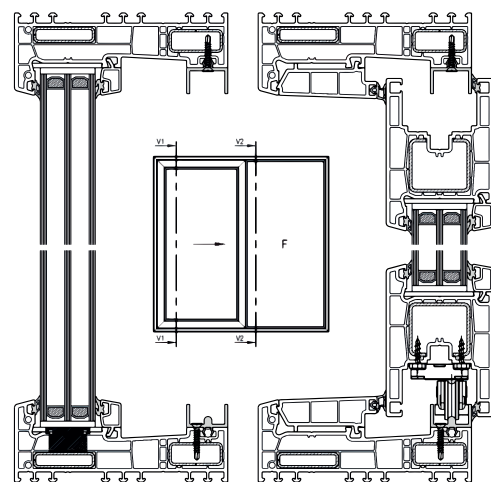

# JUMBO LINE

Sliding system

Large-span windows system to enjoy the best views.

- › Equipped with internal galvanized steel reinforcement.
- › Suitable for glazing glass panes of up to 1,34" thick.
- › Frame-attachable guide system supporting multiple panels.
- › Maximum inertia reinforcements ensure excellent functionality and performance.
- › Compatible with PVC mosquito screens.



» Systems with two or more guides.

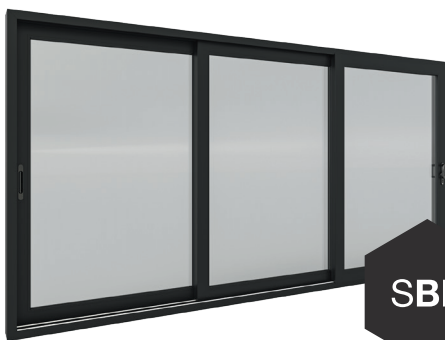
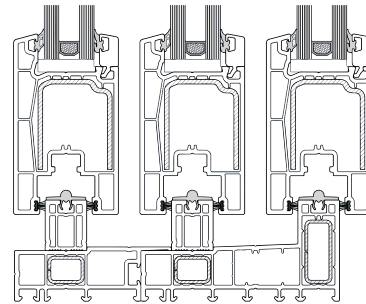
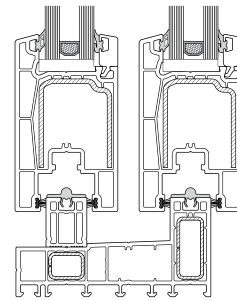

SBD

Sello  
Buen  
Diseño  
argentino

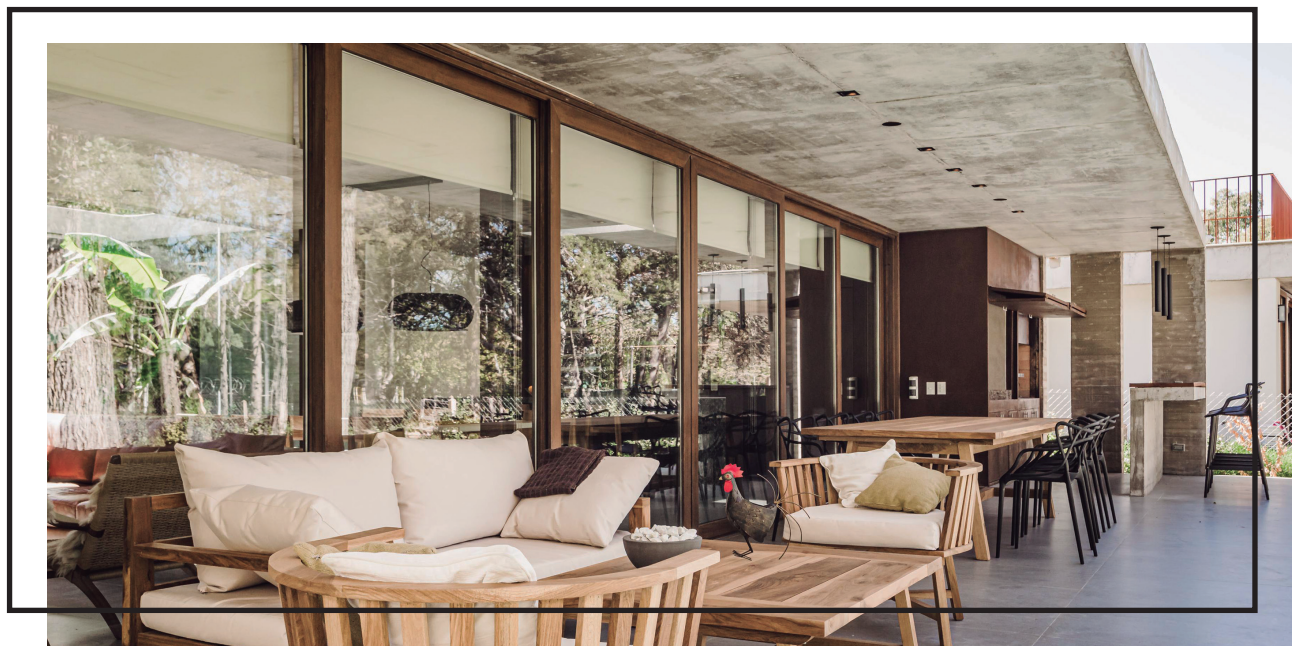
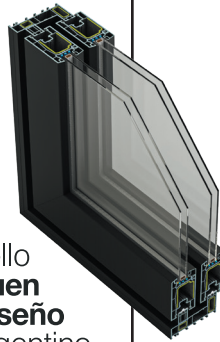

# PRIME LINE

## Sliding system

- › Sliding system suitable for 2, 3, 4 and 6 movable panels.
- › Suitable for glazing glass panes of up to 0,94”.
- › New central meeting points.

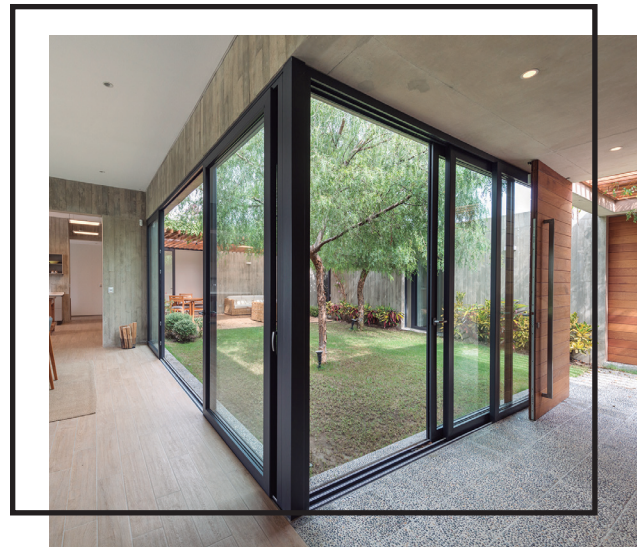
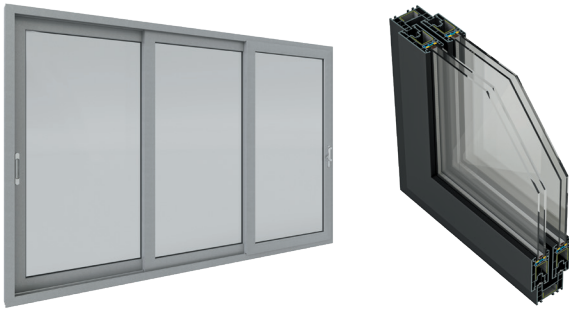

### » Systems with two and three guides

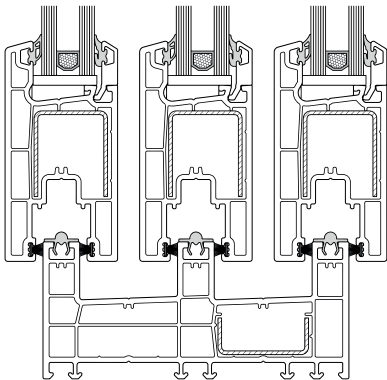
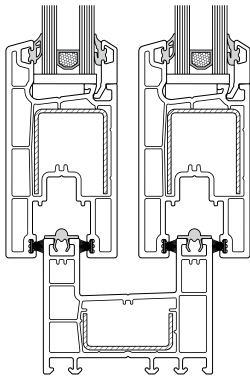

### » Prime panel 74

Lighter panel designed for smaller windows.

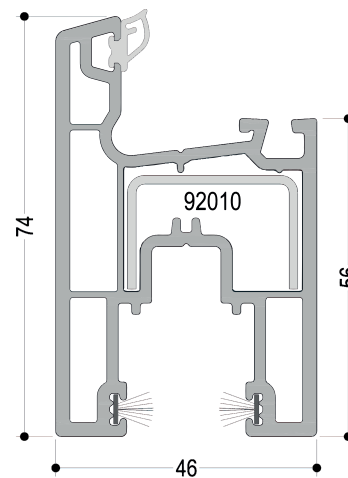

**11033:**  
Prime panel 74

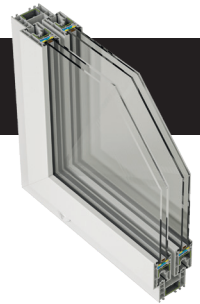

# ADVANCE LINE

## Sliding system

- › Compact sliding system up to 6 movable panels.
- › Suitable for glazing glass panes of up to 0,67" thick.
- › Excellent cost/benefit ratio.



### » Systems with two and three guides

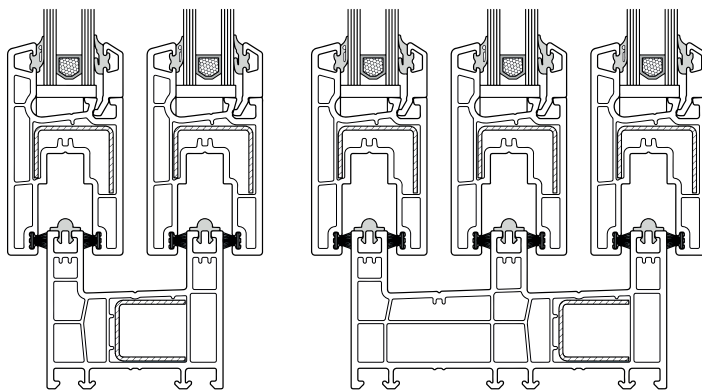

## Fixed-mobile monorail

### » sliding system

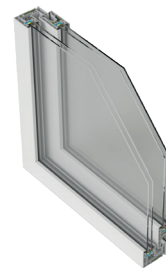

Monorail sliding window available with one sliding and one fixed panel or with a central fixed panel and two side sliding panels.

**11244:** Advance movable-fixed frame

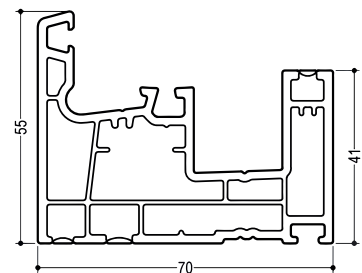

**11330:** Advance movable-fixed panel

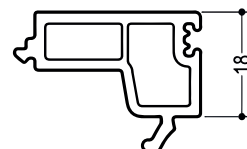

## » Complementary products

# COVER SYSTEM

**Specially designed for the renovation and retrofit of any type of windows and doors: painted sheet, wood, iron, aluminium, composite materials, etc.**

The use of the Cover System makes the frame of the pre-existing window or door system remain completely hidden. This is an excellent solution for those technical problems that arise during the recycling process, in terms of both quality and aesthetics, since it does not require any masonry work before or after installation. It is cost-effective and easy to install.

**Suitable for both exterior and interior installations.**

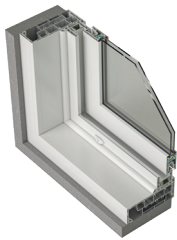

Exterior



Interior

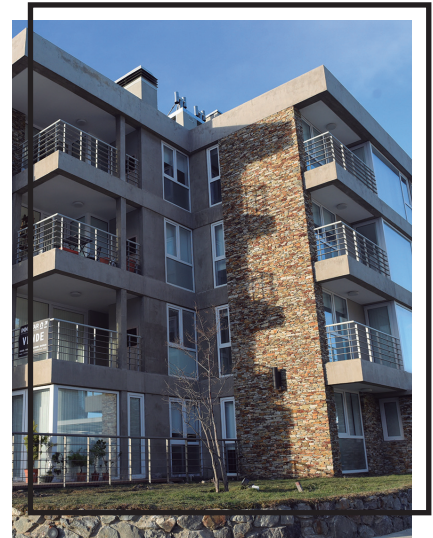

## MOSQUITO SCREENS

› Fixed or sliding mosquito screen systems.

› Exclusively developed by **MUCHTEK** and compatible with all our designs.

› Available in a wide variety of colors and textures.

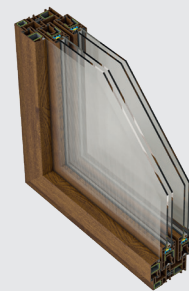

## SHUTTER

Provides darkening, privacy, and additional protection for the windows.

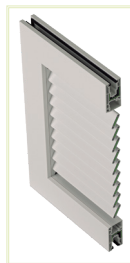

## LOUVER

Designed to provide permanent ventilation and solar control while maintaining room privacy.



## CLIPPING FINS

Specially designed to optimize installation in both industrialized and dry-construction systems.

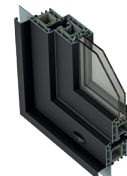
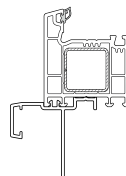

The widest range of colors and textures for your windows.

# Choose the style you like best.

German quality and technology in wood-like, matte and glossy laminations for PVC profiles.

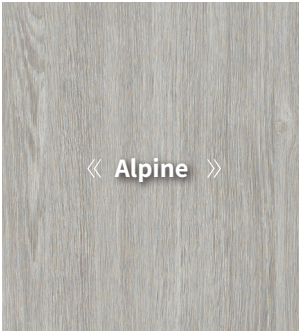

« Alpine »



« Peltre »



« Metallic Grey »

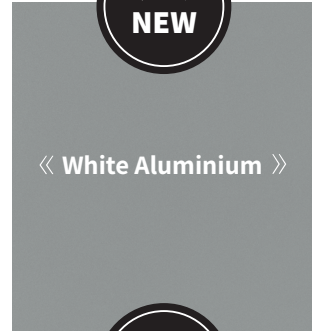

« White Aluminium »

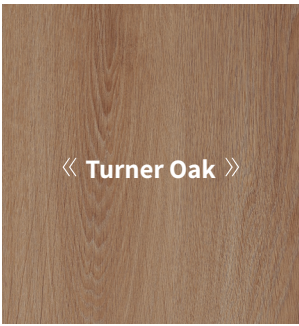

« Turner Oak »

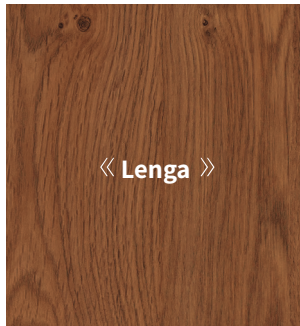

« Lenga »

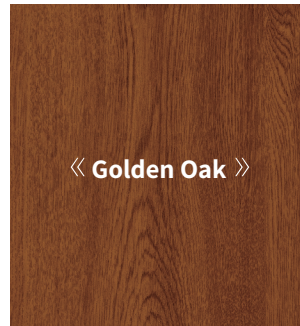

« Golden Oak »



« Umbra Grau »



« Toffee »

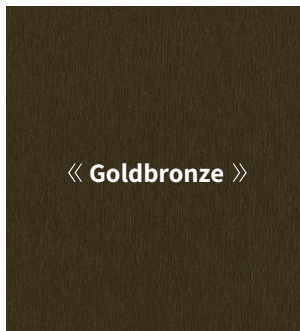

« Goldbronze »

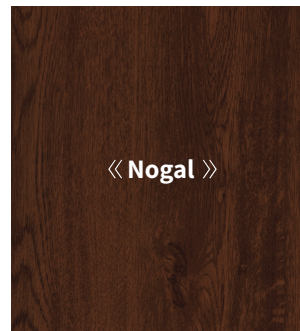

« Nogal »

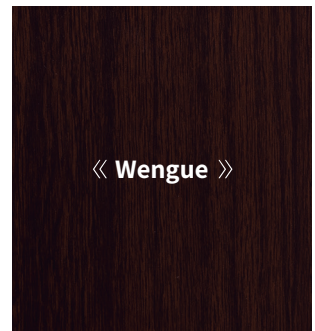

« Wengue »



« Grey Oak »



« Grafito »

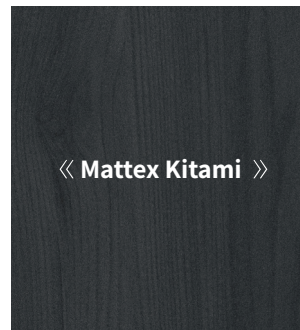

« Mattex Kitami »

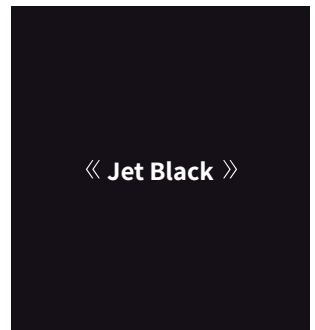

« Jet Black »

\*These images show the different laminated options and may slightly vary from the actual colors.



# « TUBULARS »

## Sunshades - Pergolas - Privacy Screens - Louvers

PVC Sunshades - Pergolas - Privacy Screens - Louvers. An excellent option for decorating spaces that require solar control and air circulation.

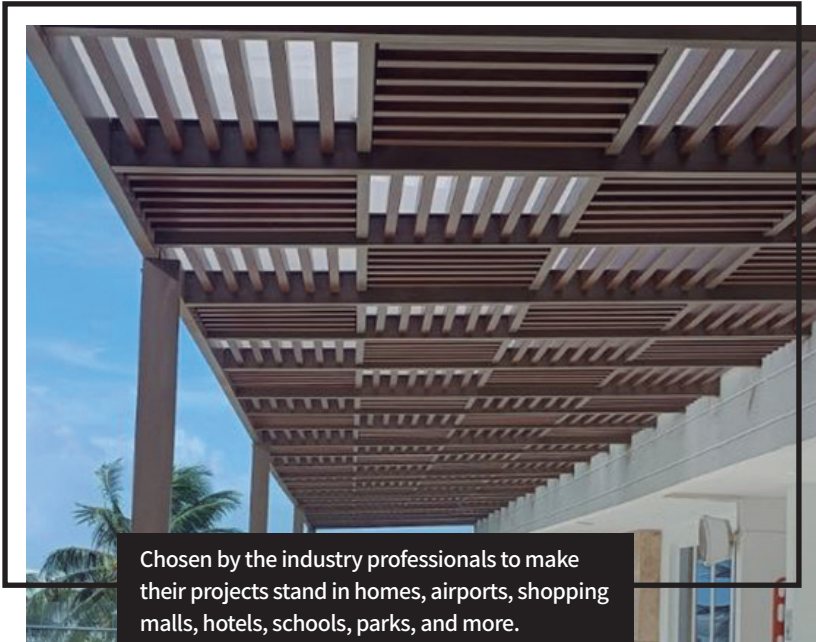

Chosen by the industry professionals to make their projects stand in homes, airports, shopping malls, hotels, schools, parks, and more.

» Available for lamination with a wide range of colors and textures.

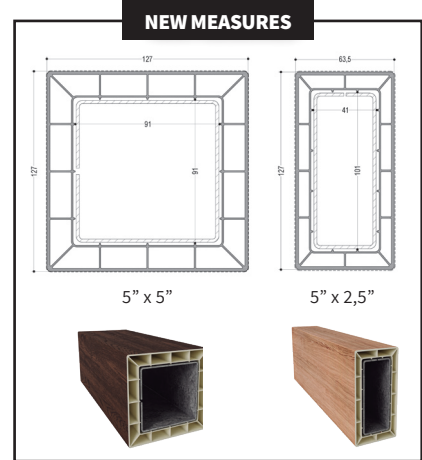
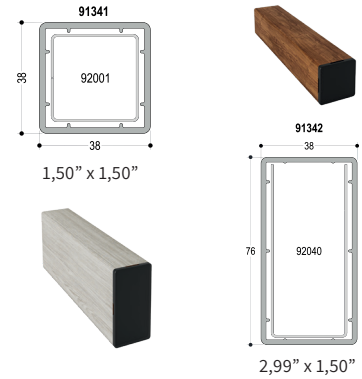

# « CLADDING »

## Ceiling - Wall - Covering

Recommended for internal and semi-covered use.

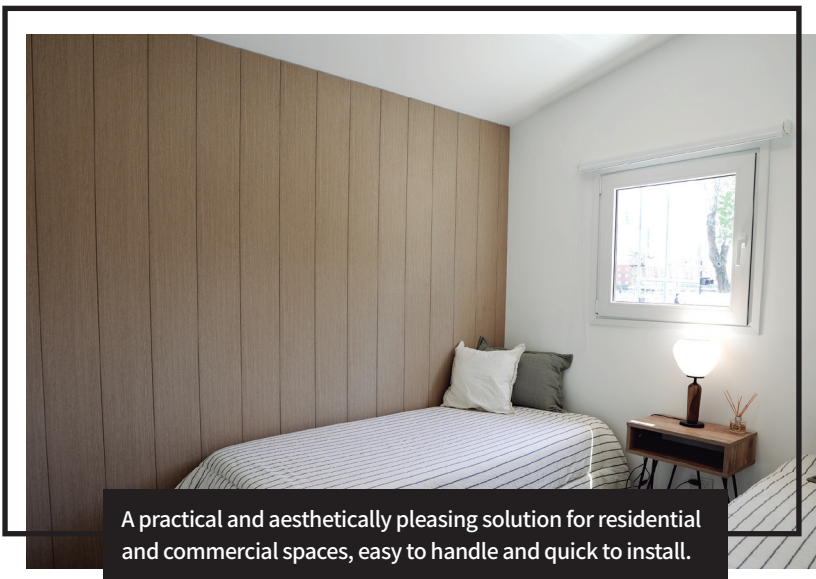

A practical and aesthetically pleasing solution for residential and commercial spaces, easy to handle and quick to install.



Wide range of colors and textures to choose the most suitable design for your space:

- White
- Oak
- Eucalyptus
- Poplar
- Walnut
- Teak
- White concrete
- Concrete C

Scan the QR code

to learn more about our architectural products



# 《WALL PANEL》

## Interior

For interior design, decoration and architectural finishes.

A wide variety of colors and textures, combining PVC resistance and durability to provide an excellent solution for each space.

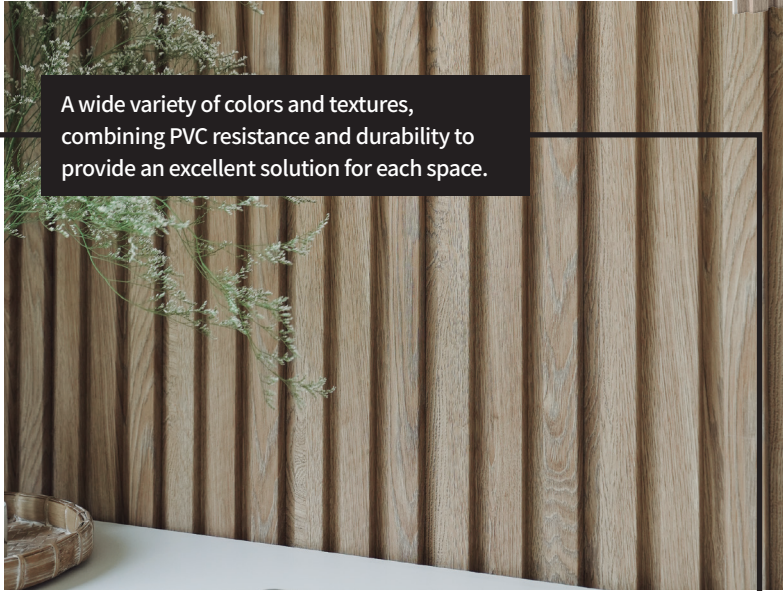

Interior use only



《Oak》



《Eucalyptus》



《Poplar》



《Walnut》



《Teak》



Easy to install and clean.



No maintenance required.



Hypoallergenic, moisture-resistant, stain-resistant, termite-resistant.



Great thermal comfort.

Suitable for direct installation on all types of walls, cemented surfaces and other materials.

# 《WALL PANEL》

## Exterior

Ideal premium cladding for facades and exterior surroundings.



Designed to maintain the appearance and texture of natural wood combined with PVC resistance and durability.



» Wide range of colors and textures available.



No maintenance required.



UV-resistant.



Moisture- and water-resistant.



Sustainable, eco-friendly and recyclable.



Exterior-resistant.



Unalterable material.

Scan the QR code

to learn more about our architectural products.



« DECKS »



The PVC Deck is an ideal choice for architectural projects that demand durability, resistance and low maintenance.

Its innovative design and advanced technology make it a versatile, strong and long-lasting material.



Fire-resistant and antibacterial.



No maintenance required.



Easy and quick to install.



Moisture- and water-resistant.

» Abrasion-resistant laminated PVC



Honey Oak



Mountain Oak



Nutmeg Oak

» Acrylic-coated UPVC



ASA Brown



ASA Gray

« BASEBOARDS »



Composed of two pieces

Base + trim, providing a second function as a cable duct while ensuring impact resistance. Suitable for all types of spaces, including those with strict hygiene and health standards.

Suitable for cutting, mitring, screwing or adhering with silicone cement ensuring easy installation similar to traditional baseboards, but with all the advantages of PVC.



Water- and moisture-resistant.



Soft and homogenous texture.



Splinter free.



Fire-resistant and antibacterial.



No maintenance required.



Quick and easy to install.



Long-lasting material.



Environmentally friendly.

Wide range of colors and textures to choose the most suitable design for your space

# Mûchtek

TECNOFILES GROUP

Our history reflects the consolidation of a sustainable company, a leader in the manufacturing of high-performance PVC profiles of windows and doors and architectural products.

**More than 50,000 construction projects per year in Latin America guarantee our leadership.**



DEPARTMENT OF REGULATORY AND ECONOMIC RESOURCES (RER). BOARD AND CODE ADMINISTRATION DIVISION. NOTICE OF ACCEPTANCE (NOA)

MUCHTEK obtained the acceptance certificate to operate in the State of Florida, United States of America.  
Carried out testing: fire resistance and durability.

**We are the leading company with a network of more than 450 certified manufacturing workshops across Latin America, all operating in compliance with European manufacturing standards.**

We have commercial offices and logistics and distribution centers across Brazil, Chile and Mexico as well as international branches and a wide Network of Fabrication Workshops in Aruba, Bolivia, Colombia, Costa Rica, Ecuador, Panama, Paraguay, Peru, Uruguay and other countries across Latin America and the Caribbean.

## Certified manufacturing workshops



### ARGENTINA

#### COMMERCIAL OFFICES

7904 Libertador Ave., (C1429BMZ)  
1st Floor Showroom, 2nd, 3rd, 4th and 11th floor.  
Buenos Aires (CABA) - Argentina  
Tel. (5411) 5281-6650

#### SUBSIDIARIES

### BRAZIL

Tel: (51) 98954 0764  
infobrasil@muchtekt.com

#### MANUFACTURING PLANT

9061 Benito Pérez Galdós Ave.,  
(B1657AIR) Pablo Podestá,  
Buenos Aires - Argentina.

#### LAMINATION PLANT

2250 Julio Moreno (B1657AIR)  
Pablo Podestá, Buenos Aires -  
Argentina.

### CHILE

Tel: (56) 2 3262 7840  
infochile@muchtekt.com

### MÉXICO

Tel: (52) 0133 3852 0189  
infomexico@muchtekt.com

## Building a legacy



/Muchtekt.TecnoperfilesGroup  
perfiles@muchtekt.com  
www.muchtekt.com



Whatsapp  
Virtual Assitant  
(54) 11 7221 4600



/inoutdesign.muchtekt  
in-out@muchtekt.com  
inoutmuchtekt.com